

Further 



**Your idea.**  
**Build it. Scale it.**  
**Go Further.**

[www.gofurther.digital](http://www.gofurther.digital)



**Your idea.  
Build it. Scale it.  
Go Further.**

FURTHER DIGITAL SOLUTIONS

## **Your partners in digital innovation**



### ***Hi there!***

I am very excited to help you build a fantastic digital product! Here's what you can expect when working with us.

We don't like to execute. If we feel one of your ideas won't work, we'll let you know.

We believe in the power of a handshake. We value openness and honesty. We think long-term. Hopefully, so do you!



## Our team

**Strategists, developers** and **designers** work together to guide you through the whole product development process from concept validation to growing your company into a household name.

**07**

Developers

**01**

UX Designer

**01**

Product Owner

**01**

Product Strategist

**01**

QA Specialist

TRUSTED BY

*P&G*

 MSD

  
SAMSUNG ENGINEERING

nJoy

 Praktiker

  
CORVINUS  
UNIVERSITY  
of BUDAPEST

 HARBORSZ

 Onrobot

 STEIGER

## Full-service digital product development

Our value as a full-service digital product agency is bringing business, user experience and technology under the same roof, guiding you through the whole product development process.

**From idea to execution and beyond.**

We are focused on providing customer-centric digital solutions: we take our time to better understand your business, which in turn allows us to build solutions that are tailored specifically to your needs.

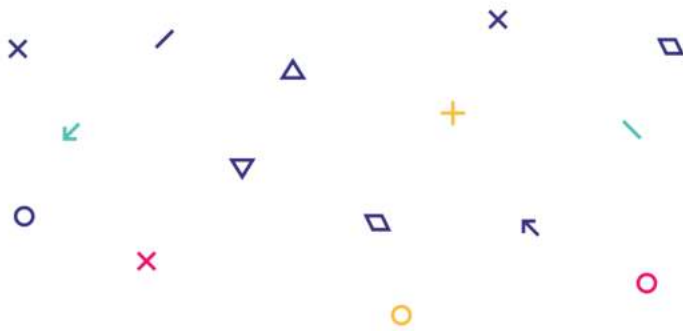

## Our approach

A collaborative process. As opposed to a traditional agency, working with Further means you'll be involved from the very beginning and throughout the project. We find this is the best way to make sure we're building something you'll love and your users will love to use.

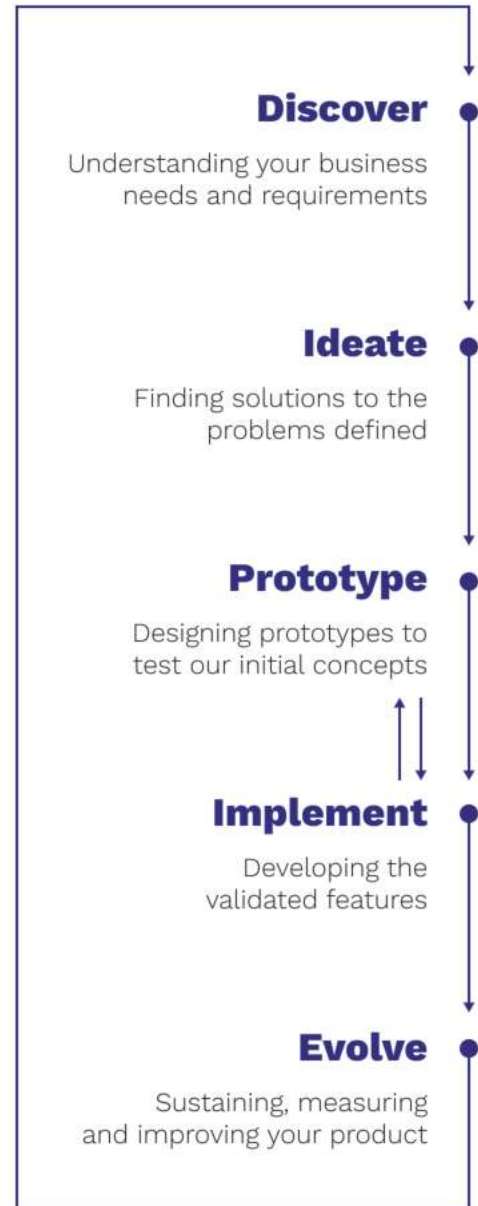



# Our values



## **100% Remote Team**

We strongly believe that remote working is the future. It gives our teammates more freedom and flexibility to handle life's challenges which in turn leads to a better well-being and a happier and more productive team.



## **Open Source**

The community has given us so much along the years. We try to give back whenever we can by contributing to community projects or releasing some of our work as open source.



## **Constant Learning**

We firmly believe that in the fast-paced IT world, you have to continuously learn to stay competitive. We attend conferences and meetups whenever possible to educate ourselves. Furthermore, we reserve Friday afternoons to work on something together, to learn a new technology or to discuss how we can improve on our work processes.



# Our specialties



## UX Research

We combine qualitative methods like user interviews, card sorting and usability testing with quantitative methods such as A/B testing to gain treasured information which can be fed into the design process.



## Wireframing and Prototyping

Creating wireframes and prototypes is a cost-effective method of visualising the relationships and hierarchy of elements within an application.



## UI Design

When designing a user interface, we always take care to not only create something beautiful, but usable as well. We make sure that each UI is based on a design system, making it easy for our frontend developer colleagues to create reusable components.



## Design Sprints

We love design sprints, as they allow us to quickly map out user pain points and needs, design a new product or improve an existing one. It condenses weeks worth of work into just a handful of days.

# Our specialties

## Hybrid or Native Mobile Apps

Whether you need a more budget-conscious solution or a high-performance native solution, we've got you covered.

 Flutter  React Native  Swift

 ELECTRON  Kotlin  CORDOVA

## Single Page and Progressive Web Applications

Modern users expect the applications they engage with to be seamless. Our team has deep experience in building complex, enterprise-focused single page applications that facilitate delightful user experiences.

 Vue.js  React  TypeScript





# Our specialties

## Scalable Backend Architectures

Performant user interfaces need to be backed by highly available and scalable services. Our teams focus on developing decoupled microservices which increases the overall stability, testability and scalability of the business logic and database layers.



## Cloud & DevOps

In order for the applications we build to reach and adequately serve the end user, we configure our applications to match enterprise environmental stability and autoscale based on the user load.



# Why outsource here?



## Lower Costs

Besides offering some of the best talent in the world, Romania and Hungary are also cost effective alternatives. You should expect rates to be around 30% to 50% lower than in the US, the UK or Western Europe.



## Development Skills

Speaking of talent, why is it that local developers are so good? Because these two countries combined produce over 15.000 software engineers each year at renowned technical education centers in Bucharest, Timisoara or Cluj in Romania, and of course Budapest in Hungary.



### **Cultural Fit**

Although it might surprise you, our culture, values, and lifestyle is very similar to the one of the US or Western Europe. More importantly, over 60% of young people speak English, making it easy to work and communicate with us. At Further, we speak English, German and Italian, in addition to Romanian and Hungarian.



### **Compatible Timezones**

Outsourcing projects often suffer because of incompatible timezones. Fortunately, outsourcing to Romania or Hungary means you'll have 100% overlap if you're based in Europe, and up to 3 hours if you are in the US!



### **Easy Access**

If you'd like to meet in person, it's easiest to meet us in Timisoara (RO) or Budapest (HU). Luckily, both cities are reachable in just a couple of hours of flight from all over Europe. We once had a client who chose us, because it was easy for him to fly to Budapest from Tel-Aviv. He chose us for ease of access, but stayed because of the results and quality of the partnership!

# Collaboration methods

	<b>Project-based</b>	<b>Time &amp; Material</b>	<b>Sprint-based</b>
	Recommended for smaller projects or when scope is specified in detail	Primarily used on supported projects (not in active development) or when taking over existing projects from 3rd parties	Recommended for developing greenfield digital products
Cost	<b>\$\$\$</b>	<b>\$\$</b>	<b>\$</b>
Payment Schedule	Down payment + partial invoices	Monthly	Every 2 weeks
Team Size	Min. 2 devs + 1 PM	Min. 1 dev + 1 PM	Min. 2 devs + 1 PO + 1 SM
Scope	Fixed <small>(Change requests will be estimated on a T&amp;M basis)</small>	Flexible	Flexible
Budget	Fixed	Flexible	Fixed
Timeline	Fixed	Flexible	Fixed
Reserved capacity	<b>×</b>	<b>×</b>	<b>✓</b>



**Get to know  
some of our  
projects**

## P&G – Cycle Inventory Counting

P&G wanted to move their spreadsheet and paper based inventory counting to a more modern, streamlined solution.

We implemented an iOS application that leverages GPS and beacon technology to make inventorying more accurate and fast. We also made sure to seamlessly integrate this new application with their existing Azure and SAP infrastructures.

Thanks to this new solutions, P&G managed to reduce their cycle inventory counting period at their Gyöngyös facility from 3 years, to a single year!

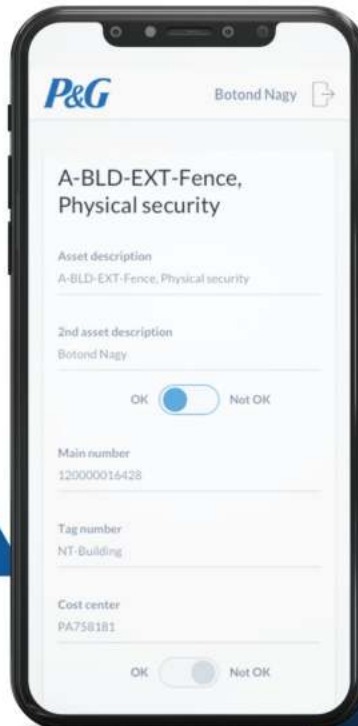
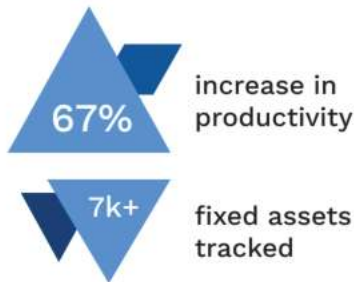

DIGITALIZING KINDERGARTENS

## Oviadmin

Educators have an incredible amount of administrative obligations towards the kindergarten operators. They have to create statistics, reports and insights on a daily basis, which takes away from the time they spend on their actual job: caring for and teaching children.

Oviadmin is a kindergarten administration platform, designed with the sole purpose of combatting this issue and freeing educators from all the unnecessary paperwork.

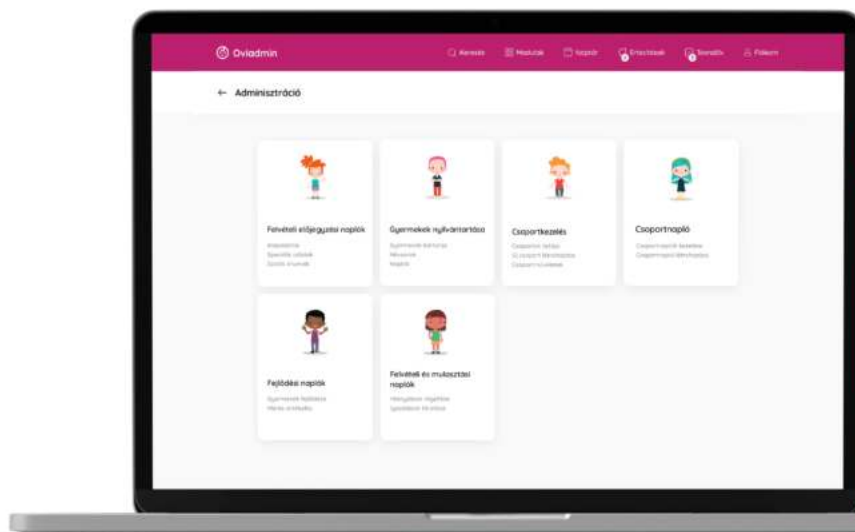

RAPID PRODUCT DEVELOPMENT

# nJoy - The Hive

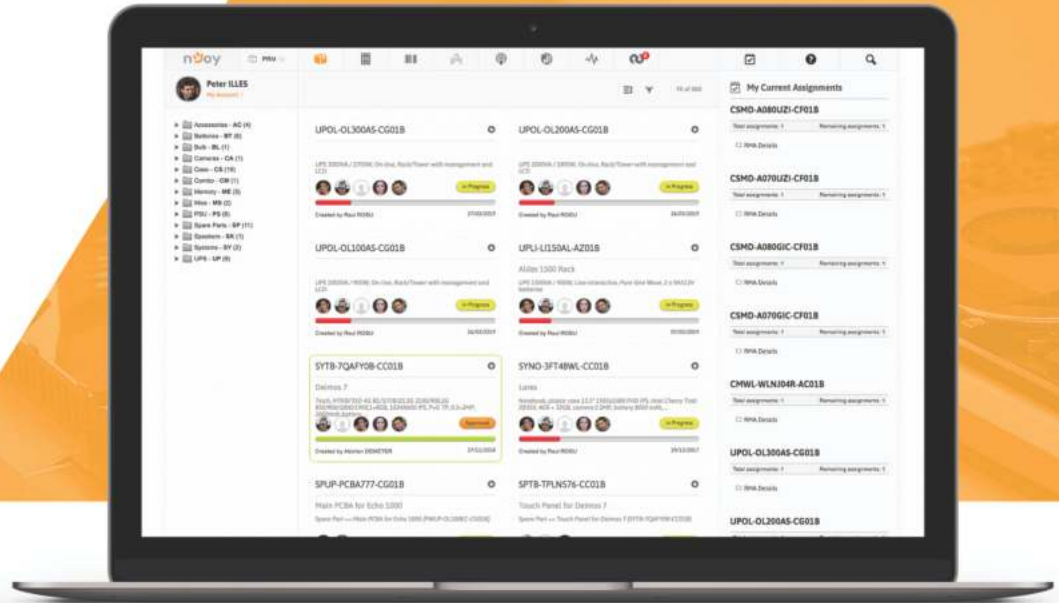

20% faster  
product development

30% decrease  
in man-hours



DAI-TECH, the fast-growing company behind the nJoy consumer electronics brand, quickly outgrew their existing software infrastructure and needed a custom-built integrated solution. They employed us to deliver a product lifecycle management tool, created from the ground up to fit their particular needs.

The end result is a flexible system, which grows proportionally with the company. Since its inception, more and more features have been added, and at the moment it acts as a central hub where DAI-TECH collaborates with manufacturers, suppliers, service centers and distributors around the world.



## THE RESULTS



CRM



Logistics



PLM (product lifecycle management)



Detailed Reporting



Sales & Forecast



Call Center



Service Center



**Adorian DEMETER,**  
General Manager at DAI-TECH

“I couldn’t imagine how developing products would work without The Hive. Since its introduction, development of new products is 20% faster and all our data is organized and easy to manage.”

FROM SALES TO PRODUCTION

# Steiger ERP

At its core, Steiger is a family business, being involved in the metalworking industry for several generations. We were contacted by them to develop a system that would automate their workflow and improve the reliability of their processes.

Prior to this, Steiger was relying on multiple software and spreadsheets to track their work, which they soon realised was ineffective and prone to errors. Our software helps them track all the work done by different departments from customer relations and sales to manufacturing.

## THE RESULTS



CRM



Quality Assurance



CPQ (Configure, price & quote)



Time Tracking



Supply Chain



In-Depth Reporting



Inventory



Employee Onboarding and Training



Project Management



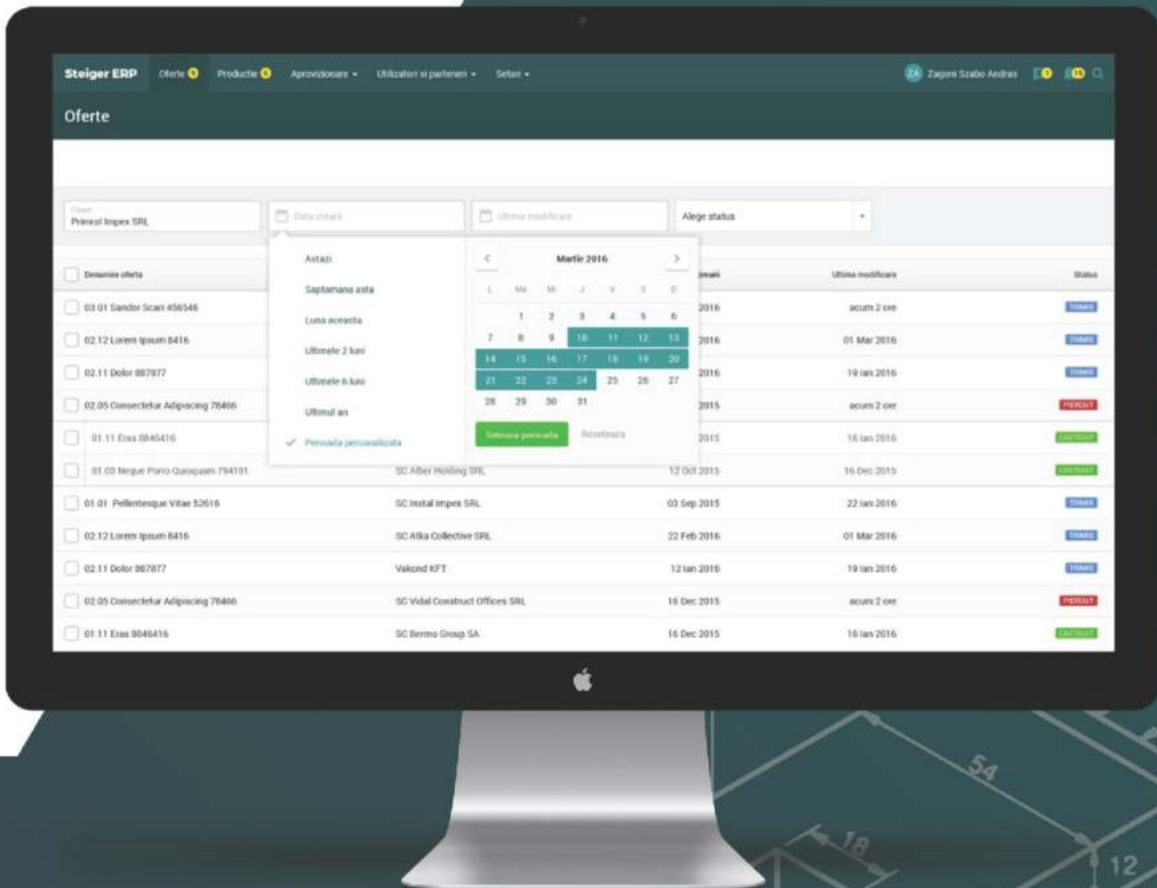

75

employees  
using the system

23%

decrease  
in man-hours

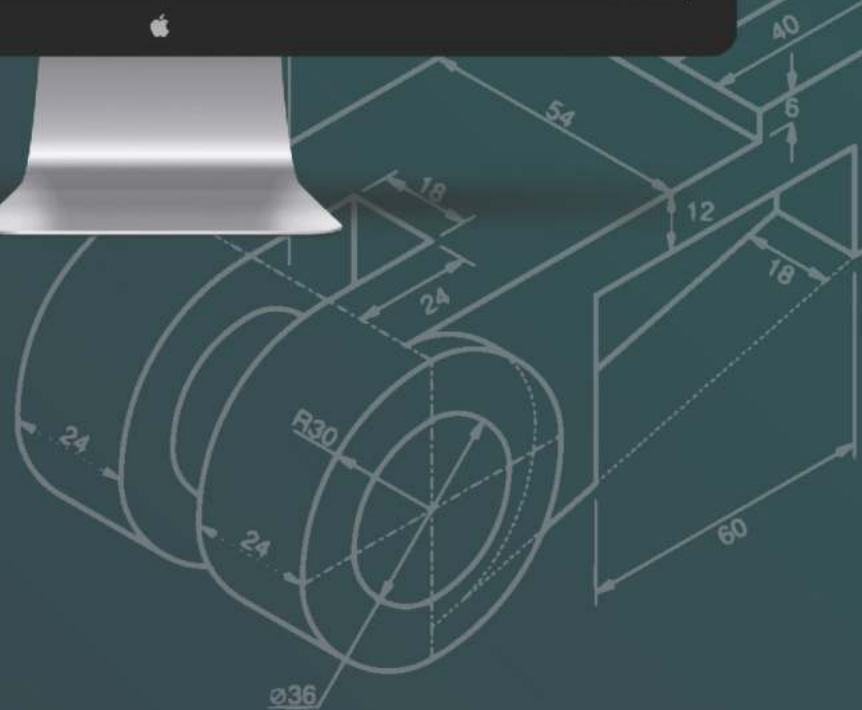

## AI-DRIVEN GARDENING

# Growpro

Our client, a landscaping company who cares for over 700 gardens across the US, approached us to help them cut their costs on pesticides by reducing the timeframe when these chemical pest control methods had to be applied.

We used machine learning methods to correlate historical weather data and the occurrence of pests. Then, using this data and knowing the weather parameters for the current year, we managed to accurately pinpoint the probable appearance date of different pests.

The product proved to be a success after internal use by our client. Together, we are currently developing V2 of this software as a mobile SaaS product, to be used by smaller landscaping companies and hobby gardeners alike.



decrease in  
pesticide costs

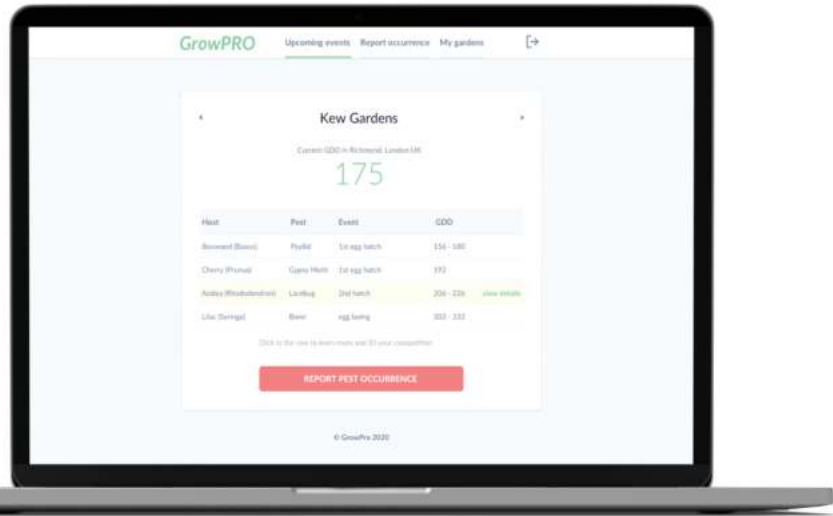

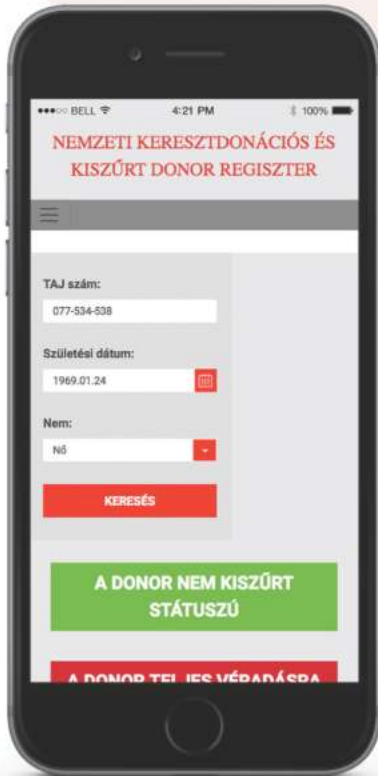

ONLINE CROSS-DONATION REGISTER

## OVSZ - NKKDR

In early 2018 we had the pleasure to work with the Hungarian National Blood Transfusion Service (OVSZ) on their online donor registry service. The online registry replaces the current paper-based systems and provides real-time communication and swift data synchronization between the OVSZ and donation centers across Hungary.



# Harborsz Logistics

Harborsz is a logistics company, whose main field of activity is the organisation of freight transfers by ferry, bridges or tunnels. Working closely with their team, we developed a system that helps them oversee all aspects of their operation.

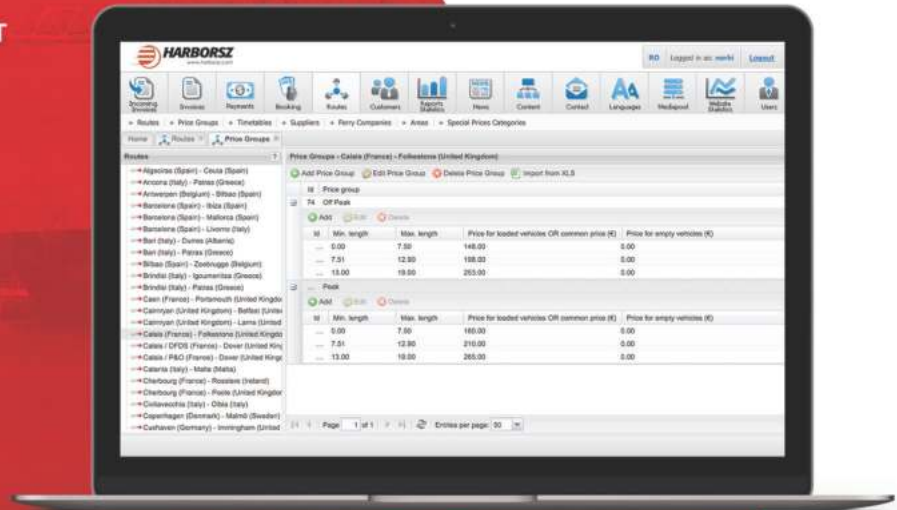

“For us the greatest advantage of the Harborsz Logistics software is that it’s a complete, integrated solution. We no longer have to carry-out our daily operations by switching between different systems and emails. This greatly reduced the frequency of errors and increased productivity.”

Edina BAKK,  
Harborsz Logistic



LIVE VIDEO TUITION

# MENTOR.ME

In early 2016 we received the task of developing mentor.me, a live video tuition platform which connects freelance mentors with interested students. mentor.me allows presenters, called mentors, to reach out and connect with prospective students, and give lectures in various fields, like business or life coaching.

We jumped at the chance to work on a different type of project and to play around with cutting-edge technologies.





**Your idea.  
Build it. Scale it. Go Further.**



**Digital Product  
Development**



**Custom  
Software Development**



**Digital  
Transformation**

[www.gofurther.digital](http://www.gofurther.digital)

[hello@gofurther.digital](mailto:hello@gofurther.digital)

+36 70 592 1697 (HU)

+40 728 156 333 (RO)

